

HOW TO MEMORIZE Africa

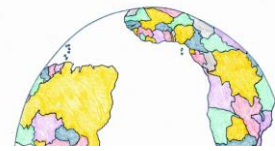

Week 1, Hidden Message Word Search North Africa CAPITALS

First, find all the words in the list. Words can go in any direction and share letters as well as cross over each other. Once you find all the words, copy the unused letters starting in the top left corner into the blanks to reveal the hidden message.

Cairo
Egypt
Tripoli
Libya
Tunis

Tunisia
Algiers
Algeria
Rabat

Morocco
Laayoune
Western Sahara
Canary Islands

A L G E R E I A I I O L S A S
T H E O N G L L Y R A C R R O
U N T R Y Y O T I A O M E A C
E N T I O P N A Y T W O I H A
C A O U I T C O N T L T G A N
S R I R I E U S I I N U L S A
I I T R T N S N B A T N A N R
I O N N E A L Y A N T I H R Y
E M O U G G A A P M M S P E I
O D J C T C L D H L M I B T S
Y T A B A R K A K A A A E S L
M O R O C C O D U D D W O E A
L Q I Z A O A F S E E F F W N
C X X Z F X V A V P U R F S D
I I T M T Q E K M M W T S R S

Fun Fact:

HOW TO MEMORIZE Africa

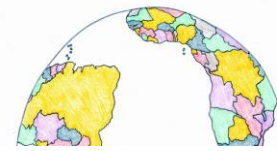

Week 1, Hidden Message Word Search North Africa CAPITALS ANSWER KEY

First, find all the words in the list. Words can go in any direction and share letters as well as cross over each other. Once you find all the words, copy the unused letters starting in the top left corner into the blanks to reveal the hidden message.

Cairo
Egypt
Tripoli
Libya
Tunis

Tunisia
Algiers
Algeria
Rabat

Morocco
Laayoune
Western Sahara
Canary Islands

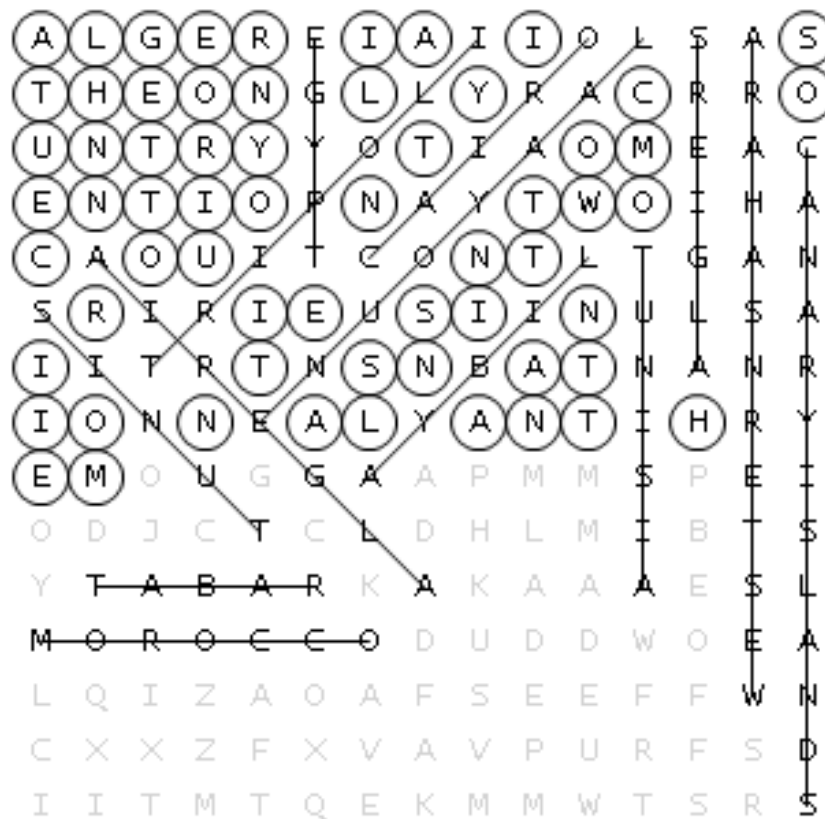

Fun Fact:

Algeria is the only country to mention two countries in its national anthem.

HOW TO MEMORIZE Africa



Week 2, Hidden Message Word Search West Africa Part 1 CAPITALS

First, find all the words in the list. Words can go in any direction and share letters as well as cross over each other. Once you find all the words, copy the unused letters starting in the top left corner into the blanks to reveal the hidden message.

Nouakchott
Mauritania
Bamako
Mali
Niamey
Niger

Dakar
Senegal
Banjul
Gambia
Bissau
Guinea-Bissau

Conakry
Guinea
Freetown
Sierra Leone

O K A M A B G A M R B I A I G
S T H E S M A L E N L E S U T
C O U N T R Y G O I N M I A I
N N L A N D I U A F R N I C A
W I N H E N A F R E E T O W N
L T A P A K R A K A D M K F J
A A X M C M A U R I T A N I A
T R G H E W K B I F Q Z J S P
C Q O E G Y S P I D K M I H O
X T X J N V P N M S M A A I X
T G U I N E A B I S S A U L U
G A M B I A S L U J N A B D I
X M Z K P C D S Z M H F U U I
I Z Y P Y R K A N O C P M U L
P H N S E N O E L A R R E I S

Fun Fact:

HOW TO MEMORIZE Africa

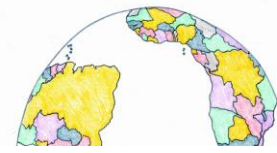

Week 2, Hidden Message Word Search West Africa Part 1 CAPITALS

ANSWER KEY

First, find all the words in the list. Words can go in any direction and share letters as well as cross over each other. Once you find all the words, copy the unused letters starting in the top left corner into the blanks to reveal the hidden message.

Nouakchott	Dakar	Conakry
Mauritania	Senegal	Guinea
Bamako	Banjul	Freetown
Mali	Gambia	Sierra Leone
Niamey	Bissau	
Niger	Guinea-Bissau	

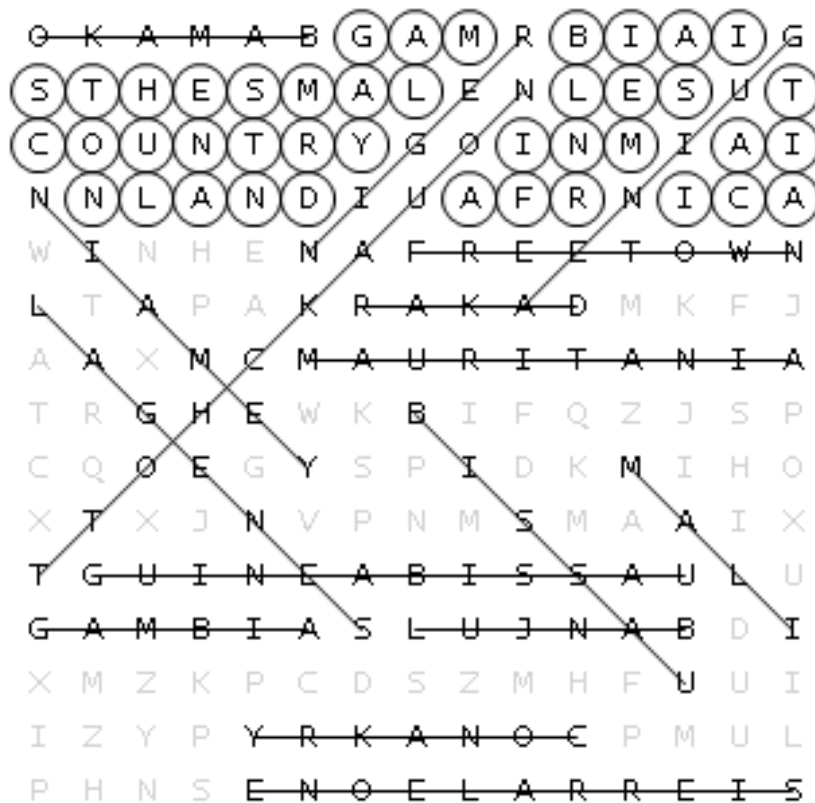

Fun Fact:

Gambia is the smallest country in mainland Africa.

HOW TO MEMORIZE Africa

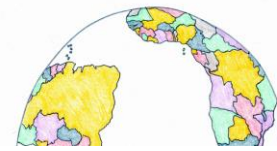

Week 3, Hidden Message Word Search West Africa Part 2 CAPITALS

First, find all the words in the list. Words can go in any direction and share letters as well as cross over each other. Once you find all the words, copy the unused letters starting in the top left corner into the blanks to reveal the hidden message.

Monrovia	Accra	Benin
Liberia	Ghana	Abuja
Yamoussoukro	Lomé	Nigeria
Cote d'Ivoire	Togo	Praia
Ouagadougou	Porto-Novo	Cape Verde
Burkina Faso		

O L I B E N M R I A S A C A Y
U T P I T I A O L I S B P N A
A A O M E N D A N F T U R E M
G R U G S E P L R R E J A S O
A I D E O B I N T J O A I A U
D M E S M B O N R O E V A C S
O A I R E G I N F N C O I B S
U B U R K I N A F A S O Q A O
G É I C O T E D L V O I R E U
O A M U Y G R J F A B B F H K
U B J O H J H P A A Y I S D R
R G T A L P P O R T O N O V O
O G N X U H Q C M C Q J V X P
M A L U A I C K I S L B A T W
O B L D S A E D R E V E P A C

Fun Fact:

_____ , _____

_____.

HOW TO MEMORIZE Africa



Week 3, Hidden Message Word Search West Africa Part 2 CAPITALS

ANSWER KEY

First, find all the words in the list. Words can go in any direction and share letters as well as cross over each other. Once you find all the words, copy the unused letters starting in the top left corner into the blanks to reveal the hidden message.

- | | | |
|---------------|------------|------------|
| Monrovia | Accra | Benin |
| Liberia | Ghana | Abuja |
| Yamoussoukro | Lomé | Nigeria |
| Cote d'Ivoire | Togo | Praia |
| Ouagadougou | Porto-Novo | Cape Verde |
| Burkina Faso | | |

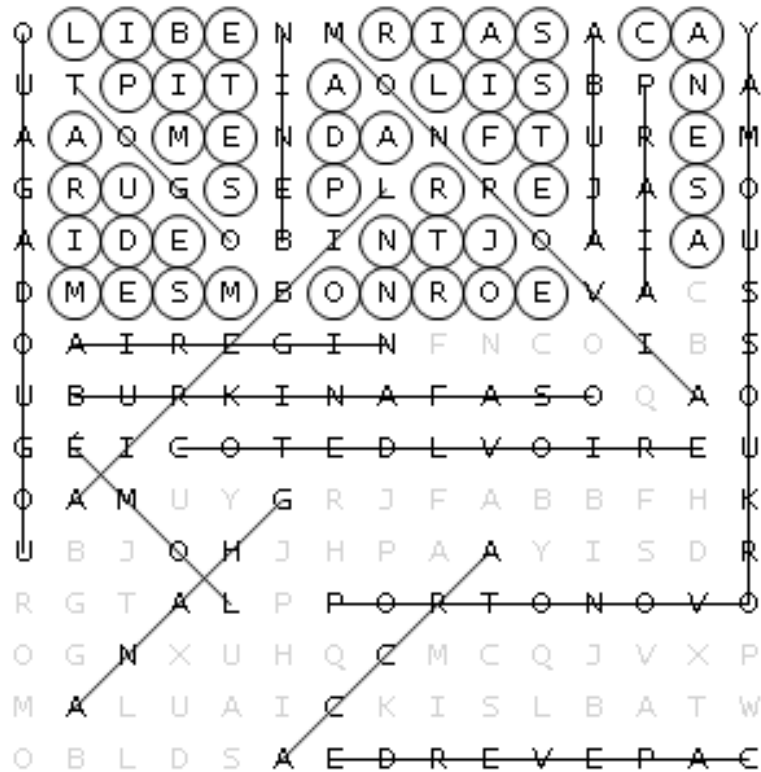

Fun Fact:

Liberia's capital is named after US President James Monroe.

HOW TO MEMORIZE Africa

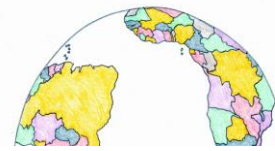

Week 4, Hidden Message Word Search Central Africa Part 1 CAPITALS

First, find all the words in the list. Words can go in any direction and share letters as well as cross over each other. Once you find all the words, copy the unused letters starting in the top left corner into the blanks to reveal the hidden message.

N'Djamena
Chad
Yaounde
Cameroon
Bangui

Central African
Khartoum
Sudan
Juba
South Sudan

S U N D A N H J A K S M O R N
E P Y D R A U M H I D S T H A
A N E G J B Y A P T B Q B Q D
Y Q Y D A A R Y A L Z F T Z U
S A N Z P T M S L P D F S A S
M M O R O E Z E B A N G U I H
J A U U Y W T R N U Z S B Z T
S V M S N B T A X A X I M Z U
P N U Y U D C A M E R O O N O
C M T E X D E M X T E F X M S
N A C I R F A L A R T N E C P
H T R O S Z I N M Q W M I V N
D A H C U Q E Z Y Y J V T H I
Z D R D E E O H N S O V J L J
Y J D J T Z G I V S C P V W H

Fun Fact:

HOW TO MEMORIZE Africa

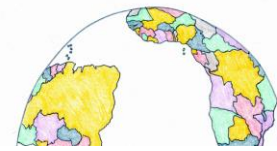

Week 4, Hidden Message Word Search Central Africa Part 1 CAPITALS

ANSWER KEY

First, find all the words in the list. Words can go in any direction and share letters as well as cross over each other. Once you find all the words, copy the unused letters starting in the top left corner into the blanks to reveal the hidden message.

N'Djamena	Central African
Chad	Khartoum
Yaounde	Sudan
Cameroon	Juba
Bangui	South Sudan

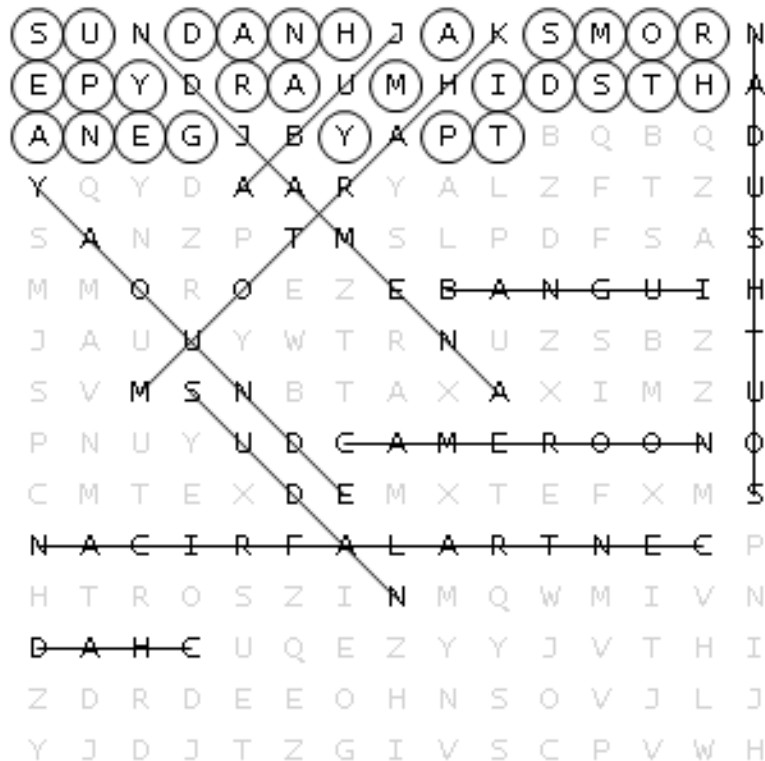

Fun Fact:

Sudan has more pyramids than Egypt.

HOW TO MEMORIZE Africa

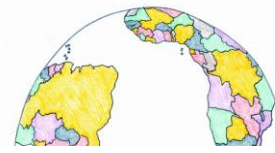

Week 5, Hidden Message Word Search Central Africa Part 2 CAPITALS

First, find all the words in the list. Words can go in any direction and share letters as well as cross over each other. Once you find all the words, copy the unused letters starting in the top left corner into the blanks to reveal the hidden message.

Malabo	Kinshasa
Guinea	Democratic
Sao Tome	Republic
Principe	Brazzaville
Libreville	Congo
Gabon	

T H E C O N G G O C L I E S
T H E W O R U P L I I D L S
D E E P E S I R T T B R L I
O B A L A M N I K A R V I E
C O N G O R E N I R E C V K
P I V M W V A C N C V C A N
N A L V R H V I S O I N Z Y
P C R B N F F P H M L I Z V
W I O O U K L E A E L L A X
N D B P T P C U S D E B R C
S A O T O M E G A T W L B P
G E X N Z Y O R T X N S D N
J S Y T G W X F P B M R L T
D G R Q Q F S E W D G R G B

Fun Fact:

_____.

HOW TO MEMORIZE Africa

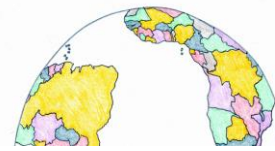

Week 5, Hidden Message Word Search Central Africa Part 2 CAPITALS

ANSWER KEY

First, find all the words in the list. Words can go in any direction and share letters as well as cross over each other. Once you find all the words, copy the unused letters starting in the top left corner into the blanks to reveal the hidden message.

Malabo	Kinshasa
Guinea	Democratic
Sao Tome	Republic
Principe	Brazzaville
Libreville	Congo
Gabon	

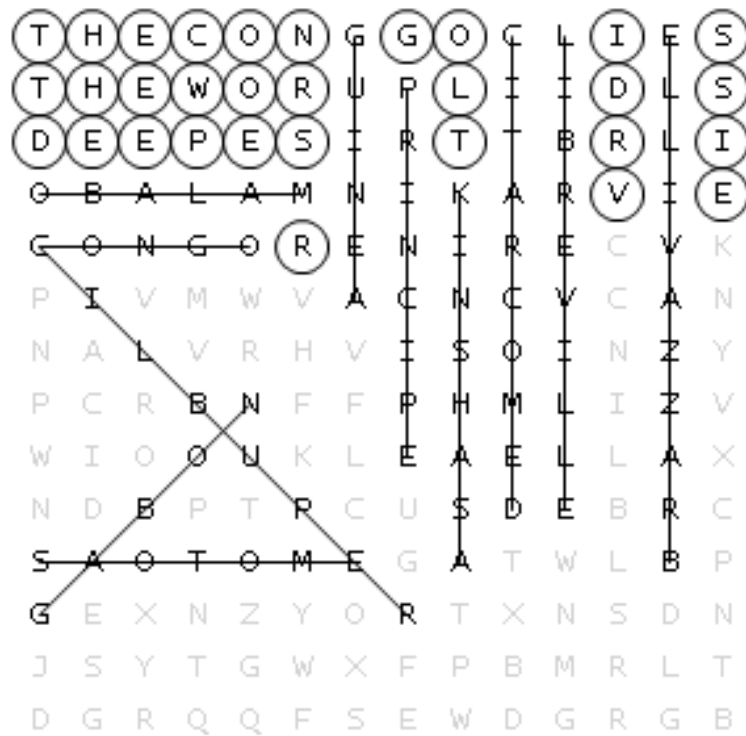

Fun Fact:

The Congo is the world's deepest river.

HOW TO MEMORIZE Africa



Week 6, Hidden Message Word Search Horn of Africa CAPITALS

First, find all the words in the list. Words can go in any direction and share letters as well as cross over each other. Once you find all the words, copy the unused letters starting in the top left corner into the blanks to reveal the hidden message.

Mogadishu	Asmara
Somalia	Eritrea
Addis Ababa	Djibouti
Ethiopia	

A N E T H I A O P I A A N R
U N N E R R W O N D T H E O
L Y M P A I C M D A R A T D
H O N M B A R I E F O O J T
U Z S C B H S J U C A I R G
M A O Z M A U R K I B E D J
W O K A B Z Q V L O E R T O
E N G A Z Z Z A U T A I H Z
I M B A E R M T H U D T C E
U A Z K D O I I O P I R U Q
M E M D S I O D C K X E I F
Y C W Z Y P S A J Y P A Q P
P W K L I O G H U B K X X U
W E I A N U H T U M H B L E

Fun Fact:

In 1960, _____

_____.

HOW TO MEMORIZE Africa



Week 6, Hidden Message Word Search Horn of Africa CAPITALS

ANSWER KEY

First, find all the words in the list. Words can go in any direction and share letters as well as cross over each other. Once you find all the words, copy the unused letters starting in the top left corner into the blanks to reveal the hidden message.

Mogadishu
Somalia
Addis Ababa
Ethiopia

Asmara
Eritrea
Djibouti

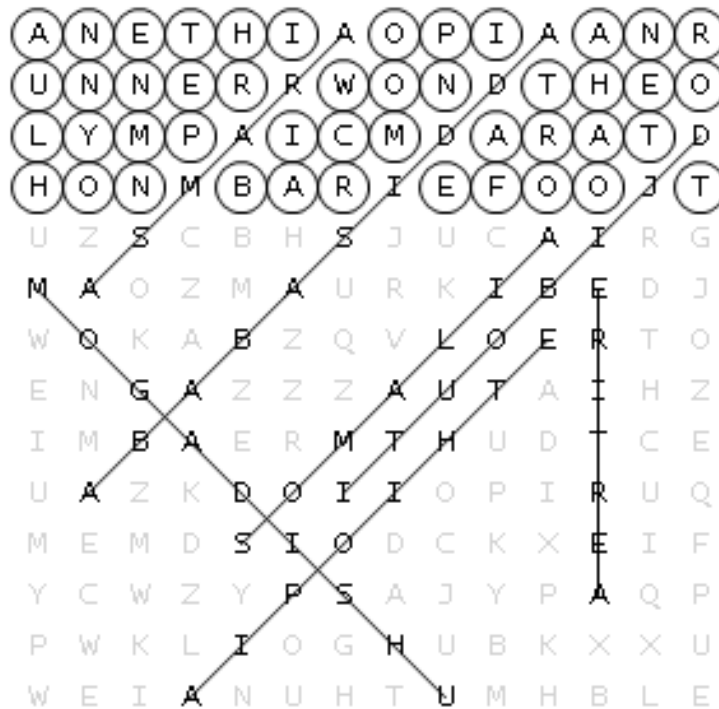

Fun Fact:

In 1960, an Ethiopian runner won the Olympic Marathon barefoot.

HOW TO MEMORIZE Africa



Week 7, Hidden Message Word Search East Africa CAPITALS

First, find all the words in the list. Words can go in any direction and share letters as well as cross over each other. Once you find all the words, copy the unused letters starting in the top left corner into the blanks to reveal the hidden message.

Nairobi	Burundi
Kenya	Kigali
Kampala	Rwanda
Uganda	Dodoma
Gitega	Tanzania
Bujumbura	

L A R G E K T R E E A U C L
I M B I N A G C O C G O N U
T C R A B M S L I A E V E I
N T A N Z P A N N A T I A M
R U O I V A I D R H I K F C
B I Z U X L A U Q A G I Y R
T U H H N A B Q Y M R G W Z
A I R T H M U N M H H A Y T
N M H U U R E D K X N L P E
Z E S J N K H G L D D I B K
A Q U U Q D S R A M O D O D
N B X P V E I P M Z Y V G D
I F N A I R O B I T M X D W
A C U T Y B C Z Z O X U D E

Fun Fact:

HOW TO MEMORIZE *Africa*



Week 7, Hidden Message Word Search *East Africa CAPITALS*

ANSWER KEY

First, find all the words in the list. Words can go in any direction and share letters as well as cross over each other. Once you find all the words, copy the unused letters starting in the top left corner into the blanks to reveal the hidden message.

- | | |
|-----------|----------|
| Nairobi | Burundi |
| Kenya | Kigali |
| Kampala | Rwanda |
| Uganda | Dodoma |
| Gitega | Tanzania |
| Bujumbura | |

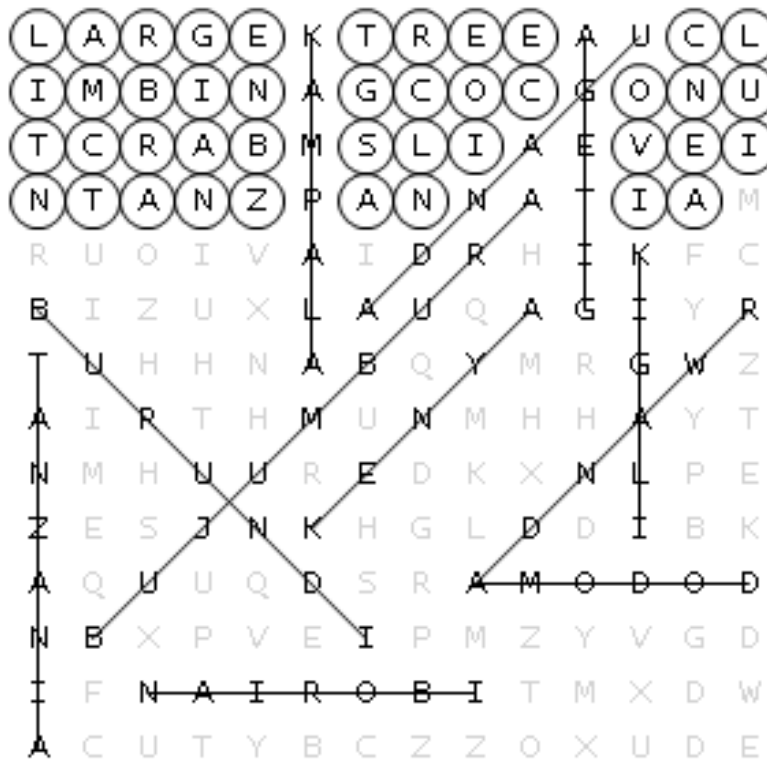

Fun Fact: Large, tree climbing coconut crabs live in Tanzania.

HOW TO MEMORIZE Africa

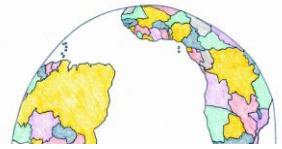

Week 8, Hidden Message Word Search Southern Africa Part 1 CAPITALS

First, find all the words in the list. Words can go in any direction and share letters as well as cross over each other. Once you find all the words, copy the unused letters starting in the top left corner into the blanks to reveal the hidden message.

Luanda
Angola
Lusaka
Zambia
Lilongwe

Malawi
Maputo
Mozambique
Harare
Zimbabwe

P O R T U A G U L E S E I Z
S T H E N O N L U Y O F A F
I C M G I H A L S L A M N G
U L O O I W A L A M B O A G
E L I O Z F A R K I N T G O
A L A L U A N D A F O U C Z
E X Z Z O V M Z P R J P H P
O T W J R N I B F T E A X A
W O C D E M G A I O J M D B
S N E E B L R W C Q E B A U
D C F A F V I F E X U W D X
F V B G E G B L D R W E B P
U W T N Y U G N B Y Q K B G
E L P V Z H C R F G N X H B

Fun Fact:

HOW TO MEMORIZE Africa



Week 8, Hidden Message Word Search Southern Africa Part 1 CAPITALS

ANSWER KEY

First, find all the words in the list. Words can go in any direction and share letters as well as cross over each other. Once you find all the words, copy the unused letters starting in the top left corner into the blanks to reveal the hidden message.

- | | |
|----------|------------|
| Luanda | Malawi |
| Angola | Maputo |
| Lusaka | Mozambique |
| Zambia | Harare |
| Lilongwe | Zimbabwe |

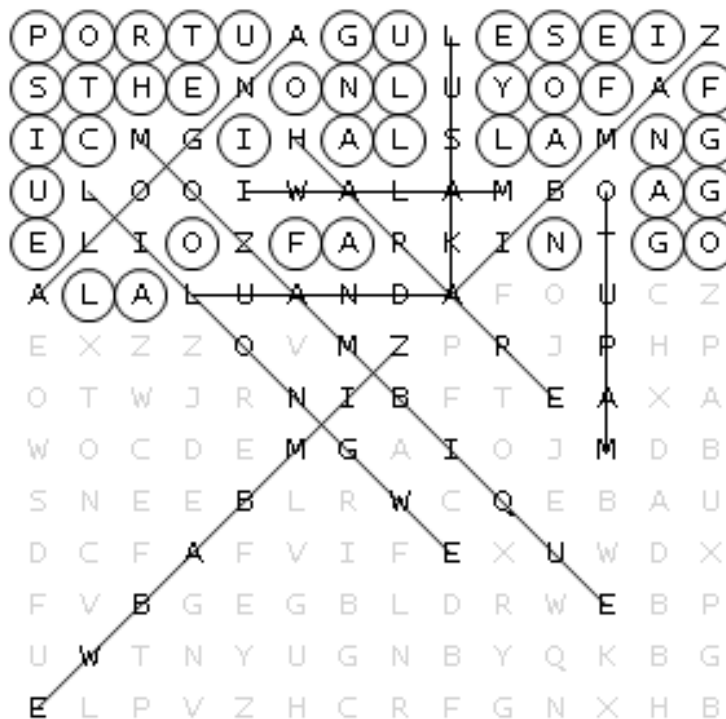

Fun Fact: Portuguese is the only official language of Angola.

HOW TO MEMORIZE Africa



Week 9, Hidden Message Word Search Southern Africa Part 2 CAPITALS

First, find all the words in the list. Words can go in any direction and share letters as well as cross over each other. Once you find all the words, copy the unused letters starting in the top left corner into the blanks to reveal the hidden message.

Windhoek
Namibia
Gaborone
Botswana

Pretoria
Cape Town
Bloemfontein
South Africa

Maseru
Lesotho
Mbabane
Lobamba
Eswatini

N A M E N M I B I A H A S S
O M B S A E O F T H E H B I
G H A W M E S T S N A N L D
W B B A I G D U W N E S O I
I O A T B N A O H T O S E L
N T N I I T T B H E W O M R
D S E N A E L D O C M D F Z
H W F I P R E T O R I A O G
O A T A U R E S A M O Q N C
E N C D J A Y F Q N U N T A
K A C I R F A H T U O S E R
L O B A M B A A X E G Y I I
U R Y K N Y G S V S Q P N E
Q T J T W U S K R H A D I Z

Fun Fact:

HOW TO MEMORIZE Africa



Week 9, Hidden Message Word Search Southern Africa Part 2 CAPITALS

ANSWER KEY

First, find all the words in the list. Words can go in any direction and share letters as well as cross over each other. Once you find all the words, copy the unused letters starting in the top left corner into the blanks to reveal the hidden message.

- | | | |
|----------|--------------|----------|
| Windhoek | Pretoria | Maseru |
| Namibia | Cape Town | Lesotho |
| Gaborone | Bloemfontein | Mbabane |
| Botswana | South Africa | Lobamba |
| | | Eswatini |

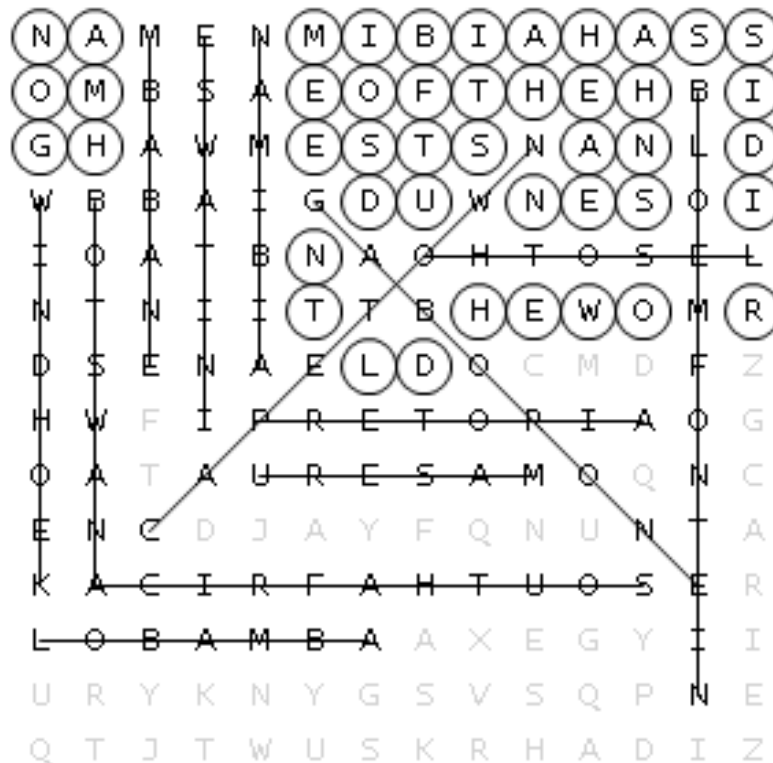

Fun Fact: Namibia has some of the highest sand dunes in the world.

HOW TO MEMORIZE *Africa*



Week 10, Hidden Message Word Search Sovereign Island Nations CAPITALS

First, find all the words in the list. Words can go in any direction and share letters as well as cross over each other. Once you find all the words, copy the unused letters starting in the top left corner into the blanks to reveal the hidden message.

Moroni
Comoros
Victoria
Seychelles

Antananarivo
Madagascar
Port Louis
Mauritius

A M T H E H I S S A S I N G C
O I O C K R O A E N C H I S F
O U R R N D O N Y T L Y I N M
A D A O O G A S C A C A R Y Y
Y X H O T N U Y H N C Z M X N
R S P W G C I A E A J M Y Z P
M U A C C I I V L N R G Q B H
X G T J O T D V L A T Q V D V
G V N E M C H X E R M T H Q N
P A V B O K F O S I B M L H E
P S J C R V X Z O V C G P C I
L E O G O J Q K M O W G C F W
G R A C S A G A D A M P S J E
P O R T L O U I S K Q F R H F
M A U R I T I U S V O Q U B Q

Fun Fact:

HOW TO MEMORIZE *Africa*



Week 10, Hidden Message Word Search Sovereign Island Nations CAPITALS

ANSWER KEY

First, find all the words in the list. Words can go in any direction and share letters as well as cross over each other. Once you find all the words, copy the unused letters starting in the top left corner into the blanks to reveal the hidden message.

Moroni
Comoros
Victoria
Seychelles

Antananarivo
Madagascar
Port Louis
Mauritius

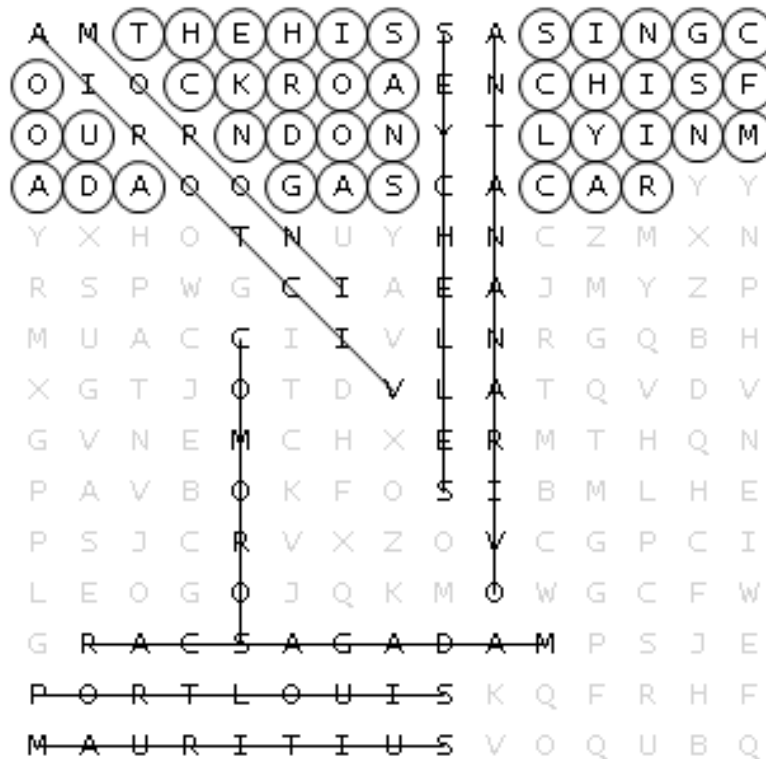

Fun Fact: The hissing cockroach is found only in Madagascar.